

BI-WELDER 1365
POWER SOURCE art. 254

SERVICE MANUAL



CONTENTS

1	- GENERAL INFORMATION	3
1.1	- Introduction	3
1.2	- General service policy	3
1.3	- Safety information	3
1.4	- Electromagnetic compatibility	3
2	- SYSTEM DESCRIPTION	4
2.1	- Introduction	4
2.2	- Technical specifications	4
2.3	- Description of power source art. 254	4
3	- MAINTENANCE	5
3.1	- Periodic inspection, cleaning	5
3.2	- Sequence of operations (fig. 3.2.1)	5
3.2.1	- Power source commands and signals	5
3.2.2	- Starting the power source	6
3.3	- Troubleshooting	7
3.3.1	- The power source does not start, control panel off	7
3.3.2	- Power source powered, fan (9) stopped	8
3.3.3	- Power source powered, leds signaling doe not indicate the correct values	8
3.3.4	- In open circuit operation, the output voltage is not regular	9
3.3.5	- In resistive load operation, the output voltage is not regular	9
3.3.6	- In TIG, arc unstable, welding irregular	10
3.4	- Error codes	11
3.4.1	- Yellow led (B) lit, with fix light	11
3.4.2	- Yellow led (B) flashes (4 fast flash with fix light for 4")	11
3.4.3	- Yellow led (B) off, during first 3 seconds after start-up (no lamp-test)	11
3.4.4	- Yellow led (B) flashes (two fast flash with 1,5 seconds pause)	11
3.4.5	- Yellow led (B) flashes (three fast flash with 1,5 seconds pause)	11
4	- COMPONENTS LIST	12
4.1	- Power source art. 254: see file ESP254.pdf enclosed at the end of the manual	12
4.2	- Components table: see file ESP254.pdf enclosed at the end of the manual	12
4.3	- Spare parts list	12
5	- ELECTRICAL DIAGRAMS	13
5.1	- Power source art. 254: see file SCHE254.pdf enclosed at the end of the manual	13
5.2	- Filter board (10) cod. 5.602.045/A	13
5.3	- Power board (13) code 5.602.044/G	13

1 - GENERAL INFORMATION

1.1 - Introduction.

The purpose of this manual is to train personnel assigned to carry out maintenance on the power source art. 254 for TIG and MMA welding systems.

1.2 - General service policy.

It is the responsibility of the customer and/or operator to use the equipment appropriately, in accordance with the instructions in the Instructions Manual, as well as to maintain the equipment and related accessories in good working condition, in compliance with the instructions provided in the Service Manual.

Any internal inspection or repairs must be carried out by qualified personnel who are responsible for any intervention on the equipment.

It is forbidden to attempt to repair damaged electronic boards or modules; replace them with original Cebora spare parts.

1.3 - Safety information.

The safety notes provided in this manual are an integral part of those given in the Instruction Manual. Therefore, before working on the machine, please read the paragraph on safety instructions in the aforementioned manual.

Always disconnect the power cord from the mains, and wait for the internal capacitors to discharge (6 minutes) before accessing the interior of the equipment.

Some internal parts, such as terminals and dissipaters, may be connected to mains or otherwise hazardous potentials. It is therefore forbidden to work with the safety guards removed from the machine unless strictly necessary. In this case, take special precautions such as wearing insulating gloves and footwear, and working in a perfectly dry environment with dry clothing.

1.4 - Electromagnetic compatibility.

Please read and observe the instructions provided in the paragraph “Electromagnetic compatibility” of the Instruction Manual.

2 - SYSTEM DESCRIPTION

2.1 - Introduction.

The BI-WELDER 1365 is a system for MMA and TIG welding, with contact arc starting.

It is made up of an electronic power source (art. 254), and a set of accessories to adapt to various applications (see list in Sales Catalogue).

The power source is controlled by a microprocessor circuit, which manages the operative functions of the welding system and operator interface.

2.2 - Technical specifications.

To verify the technical specifications, see the machine plate, Instruction Manual, and Sales Catalogue.

2.3 - Description of power source art. 254.

Art. 254 is a voltage power source with controlled current, consisting of a single-phase rectifier bridge and a DC/DC mosfet converter.

It may be powered at either 115 or 230 Vac; the unit adapts automatically based on the voltage applied to the power source input.

Referring to the electrical diagram in par. 5.1, drawing 4.1 and table 4.2, we can identify the main blocks that make up the power source.

The main switch (5) powers the filter board (10), which contains the filter to reduce conducted interference reflected in the mains.

The power board (13) is the actual welding current power source, which converts the alternating voltage at the filter board (10) output into direct current adjusted according to welding needs. It contains both the power circuit and the control circuits to manage the functions of the power source art. 254.

The welding current is regulated by the microprocessor of the power board (13), based on the signals received from potentiometer on the front panel.

The microprocessor also controls the condition of the supply voltage, to activate the supply voltage selection (115 or 230 Vac), and any safety devices necessary to protect the power source (see Error codes par. 3.4).

In the case of a 115 Vac power supply, a dedicated voltage duplicator circuit, present in the power board (13), raises the direct current on the capacitors of the power board (13) to a value close to the one obtained with a supply voltage of 230 Vac (320 Vdc approximately). Thus the DC/DC converter, connected downstream of the capacitors in series on the power board (13), always works the same way, regardless of the supply voltage.

As in previous case, also fan (9), connected to the power board (13), is ever supplied at 230 Vac, also with power source voltage mains at 115 Vac.

The front panel contains two leds for signaling over power source working condition.

The green led (C) (fig. 3.2.1) indicates power board (13) is supplied.

The meaning of the yellow led (B) is described in par. 3.4 codes error.

For power source operation is sufficient the mains voltage supply, and the only available regulation is the welding current adjusting, making up by potentiometer (A) on frontal panel.

Up on supplied with nominal voltage, the power source executes the "lamp-test", and after that output voltage generation starts. In this situation power source in ready to weld both in MMA or TIG.

In TIG, the welding arc starts by contact between the electrode and the workpiece. Power source doesn't manage the gas circuit, therefore they have to use a built-in gas valve torch (i.e.: torch T150, art. 1567.01 Cebora).

3 - MAINTENANCE

WARNINGS

ANY INTERNAL INSPECTIONS OR REPAIRS MUST BE CARRIED OUT BY QUALIFIED PERSONNEL.

BEFORE BEGINNING MAINTENANCE OPERATIONS, UNPLUG THE MACHINE FROM THE MAINS AND WAIT FOR THE INTERNAL CAPACITORS TO DISCHARGE (6 MINUTES).

3.1 - Periodic inspection, cleaning.

Periodically make sure that air is flowing properly within the aeration tunnels.

Remove any dirt or dust to ensure adequate cooling of the internal parts of the power source.

Check the condition of the output terminals, output and power supply cables of the power source; replace if damaged.

Check the condition of the internal power connections and connectors on the electronic boards; if you find “loose” connections, tighten or replace the connectors.

3.2 - Sequence of operations (fig. 3.2.1).

The following sequence represents correct functioning of the machine. It may be used as a guiding procedure for troubleshooting.

It must be carried out after each repair without any errors.

3.2.1 - Power source commands and signals.

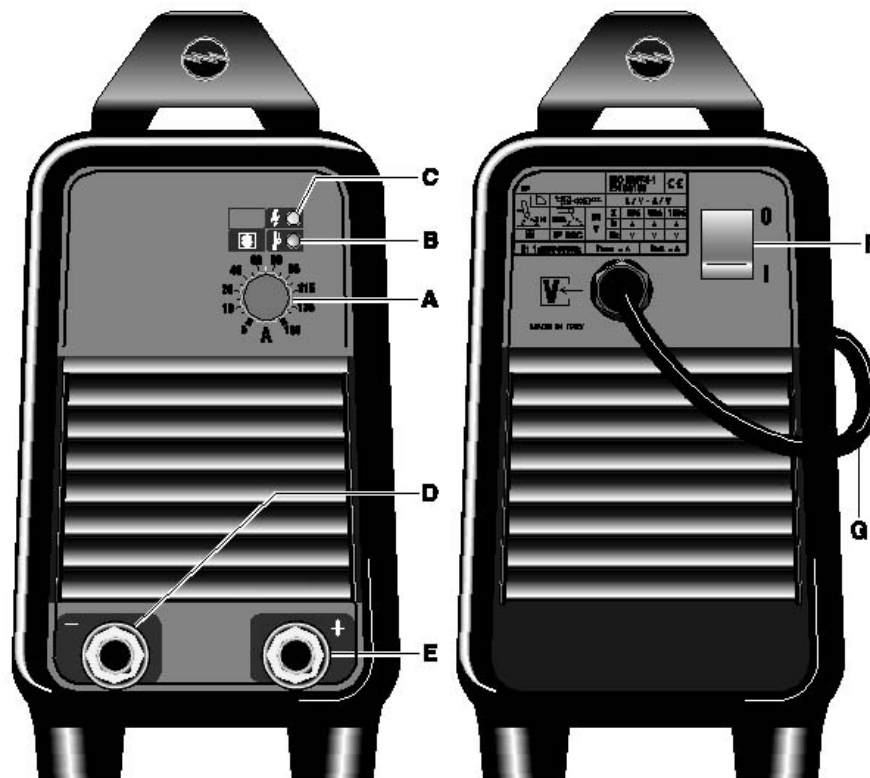

NOTE

- Operations preceded by this symbol refer to operator actions.
- ◆ Operations preceded by this symbol refer to machine responses that must occur following an operator action.

3.2.2 - Starting the power source.

- System shut off and disconnected from the mains.
- In MMA, connect the electrode clamp to the positive pole of the power source, and the cable of the negative pole of the power source to the workpiece.
- In TIG, connect the TIG torch (suggested torch T150, art. 1567.01 Cebora) to the negative pole of the power source and the cable of the positive pole of the power source to the workpiece.
- Connect the power source to the mains (115 or 230 Vac).
- Close the switch (F).
 - ◆ System powered, lamp on the switch (F) lit.
 - ◆ Fan (9) running, yellow led (B) and green (C) lit (lamp-test).
 - ◆ After three seconds, yellow led (B) off, output voltage generation starts.

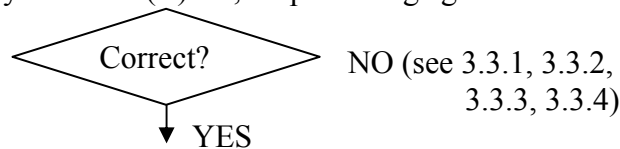
**WARNING**

DURING THE FOLLOWING TESTS DO NOT AIM THE TORCH AT PEOPLE OR PARTS OF THE BODY, BUT ONLY TOWARDS AN OPEN SPACE OR THE WORKPIECE.

- Set by the knob (A) the current based on the electrode you intend to use.
- Move the electrode clip or the torch near the workpiece.
 - ◆ Begin welding. Adjust the knob (A) to maximize the welding quality.

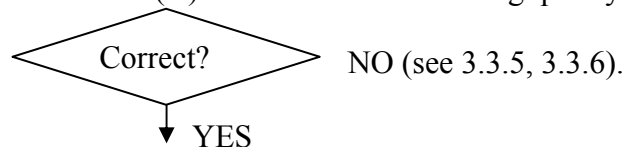

- At welding end remove electrode clamp or the torch from the workpiece.
 - ◆ The arc shuts off immediately, power source returns in open circuit output voltage generation condition, yellow led (B) off, green led (C) lit.

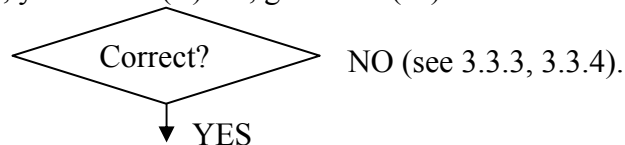

REGULAR OPERATION.

3.3 - Troubleshooting.

WARNINGS

ANY INTERNAL INSPECTIONS OR REPAIRS MUST BE CARRIED OUT BY QUALIFIED PERSONNEL.

BEFORE REMOVING THE PROTECTIVE GUARDS AND ACCESSING INTERNAL PARTS, DISCONNECT THE POWER SOURCE FROM THE MAINS AND WAIT FOR THE INTERNAL CAPACITORS TO DISCHARGE (6 MINUTES).

NOTE

Items in **boldface** describe problems that may occur on the machine (symptoms).

- Operations preceded by this symbol refer to situations the operator must determine (causes).
- ◆ Operations preceded by this symbol refer to actions the operator must perform in order to solve the problems (solutions).

3.3.1 - The power source does not start, control panel off.

MAINS SUITABILITY TEST.

- No voltage for mains protection.

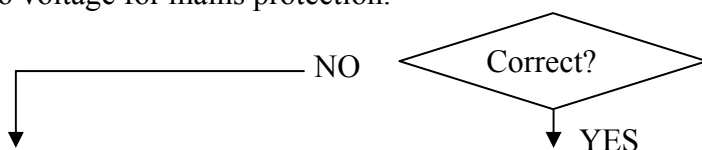

- ◆ Eliminate any short-circuits on the connections between power cable, switch (5) and board filter (10).
- ◆ Make sure that the terminals IN1 and IN2 on filter board (10) are not short-circuited between them or towards earth.
- ◆ Make sure that the mains input terminals P1 and P2 on power board (13) are not short-circuited between them or towards earth.
- ◆ Mains not suitable to power the power source (ex.: insufficient installed power).

MAINS CONNECTION TEST.

- Terminals P1 and P2 on power board (13) = 115 or 230 Vac, with switch (5) closed.

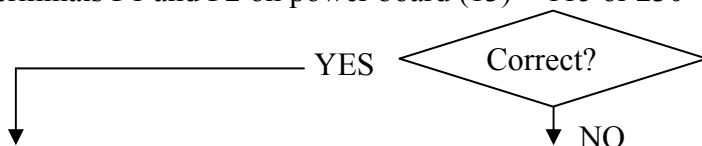

- ◆ Check mains voltage presence on terminals IN1 e IN2 on filter board (10). If absent, check power cable and plug, and switch (5), and replace if necessary. If present check connections between power board (15) and filter board (10); if correct, replace filter board (10).
- ◆ Check the mains voltage conditions.
- ◆ Replace power board (13).

3.3.2 - Power source powered, fan (9) stopped.

FAN TEST.

- Fast-on terminals of fan (9) = 230 Vac (with mains 115 or 230 Vac), with switch (5) closed.

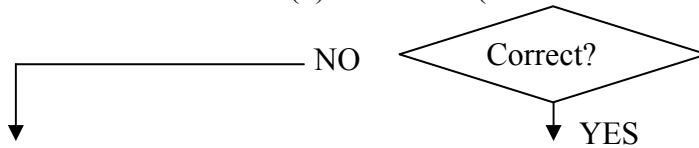

- ◆ Make sure that there are no mechanical impediments blocking the fan.
- ◆ Replace the fan (9).
- ◆ Check the wiring between the fan (9) and connection with power board (13).
- ◆ Replace the power board (13).

3.3.3 - Power source powered, leds signaling do not indicate the correct values.

LAMP-TEST.

- Upon start-up, leds yellow (B) and green (C) lit for first three seconds, after switch (5) closed.

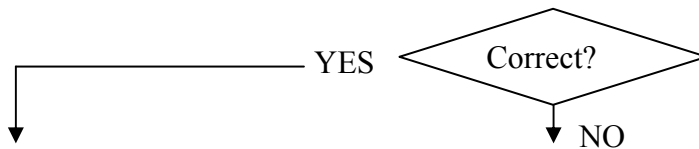

- ◆ Check power source power supply (see par. 3.3.1).
- ◆ Check voltage supply (see par. 3.4, error codes).
- ◆ Replace the power board (13).

ERROR CODE TEST.

- Upon start-up, after the lamp-test, green led (C) = lit, yellow led (B) = off.

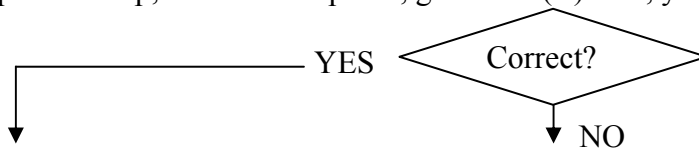

- ◆ See par. 3.4, error codes.
- ◆ Replace power board (13).
- ◆ Correct operation.

3.3.4 - In open circuit operation, the output voltage is not regular.

OPEN-CIRCUIT OUTPUT VOLTAGE TEST.

NOTE

For better precision, voltage measuring in this test must be carried out with power source output terminals (D and E fig. 3.2.1) disconnected from earth.

- Output terminal D power source (-) and output terminal E power source (+) = + 80 Vdc approximately, after “lamp-test” phase (with mains at 115 or 230 Vac).

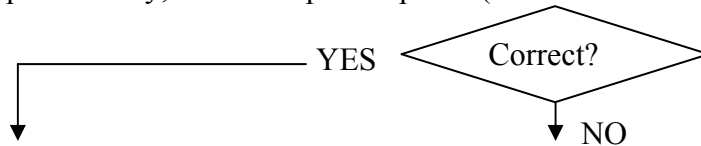

- ◆ Check the connection between the “-” and “+” terminals on the power board (13), and “D” and “E” output terminals of the power source. If you find loose connections, tighten and replace any damaged terminals.
- ◆ Replace the power board (13).
- ◆ Correct operation.

3.3.5 - In resistive load operation, the output voltage is not regular.

OUTPUT VOLTAGE TEST ON RESISTIVE LOAD.

NOTES

For the following tests use a resistive load capable of withstanding the maximum power source current. The appropriate values are shown in the table.

For better precision, voltage measuring in this test must be carried out with power source output terminals (D and E fig. 3.2.1) disconnected from earth.

Process	Resistor resistive load	Maximum output current	Power source output voltage
TIG	0,117 ohm	130 Adc	+ 15 Vdc, approx.
MMA	0,194 ohm	130 Adc	+ 25 Vdc, approx.

- Turn knob (A) clockwise to the maximum current value.
- Output terminal D power source (-) and output terminal E power source (+) = voltage values as in the table, adjustable using the knob (A).

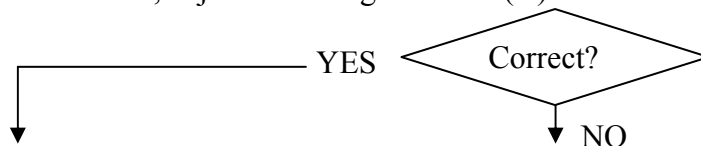

- ◆ Check the connection between the “-” and “+” terminals on the power board (13), and “D” and “E” output terminals of the power source. If you find loose connections, tighten and replace any damaged terminals.
- ◆ Check connections between potentiometer TM1 and power board (13).
- ◆ Check integrity of potentiometer TM1. If defective, replace it.
- ◆ Replace the power board (13).
- ◆ Correct operation.

3.3.6 - In TIG, arc unstable, welding irregular.**NOTE**

In TIG, the welding quality may not be acceptable due to current instability. In this case we recommend switching to MMA operation, and performing welding tests.

WELDING QUALITY TEST IN MMA.

- Power source in MMA, welding tests = good welding quality.

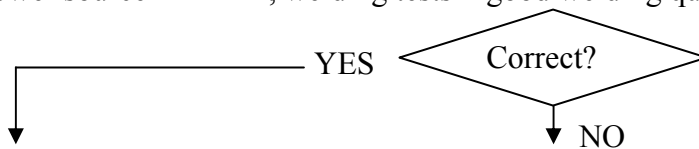

- ◆ Perform the “open circuit operation” test (par. 3.3.4) and “operation on resistive load” (par. 3.3.5).
- ◆ Replace the power board (13).
- ◆ Check the condition of the torch and electrode. If necessary, sharpen the tip of the electrode.
- ◆ Check the presence and continuity of the gas flow at the torch output.
- ◆ Check the condition of the gas valve on the torch.
- ◆ Replace the power board (13).

3.4 - Error codes.

NOTE

The moment of start-up is decisive in selecting the operating range.

With a voltage lower than 140 Vac, operation is set at 115 Vac; with a voltage greater than 140 Vac, operation is set at 230 Vac.

Once set, the range of operation does not change until the next start-up.

3.4.1 - Yellow led (B) lit, with fix light.

Alarm for temperature above limits.

The thermostat is located on the dissipater of the power mosfets of the power board (13).

The power source delivers no current, but the fan remains in operation; we therefore recommend leaving the power source powered in case of alarm for overtemperature.

Check the temperature of the dissipaters of the power modules on the power board (13), and if necessary wait for them to cool completely. If the alarm persists, replace power board (13). If the alarm is reset, check the efficiency of ventilation, make sure the ambient temperature is not too high, and that the working cycle is not greater than the one specified.

3.4.2 - Yellow led (B) flashes (4 fast flash with fix light for 4”).

Alarm for high supply voltage, greater than approximately 275 Vac, at start-up.

The power source delivers no current, but inside circuits and fan are still subjected to mains voltage; we therefore recommend that you avoid remaining in this condition for long.

The power source returns to operation, when the voltage becomes lower than approximately 270 Vac.

WARNING

The power source art. 254 is **not** protected against supply voltages greater than 300 Vac. Any mains power supply at 400 Vac will seriously damage the power source.

3.4.3 - Yellow led (B) off, during first 3 seconds after start-up (no lamp-test).

Alarm for low supply voltage, less than approximately 95 Vac, at start-up.

The power source delivers no current, also if leds signaling status is the same of normal operation after lamp-test.

The power source returns to operation, with the normal pre-charge sequence, when the voltage becomes greater than approximately 98 Vac, remaining at reduced performance levels until the voltage approaches the rated value.

3.4.4 - Yellow led (B) flashes (two fast flash with 1,5 seconds pause).

Alarm for low supply voltage, less than approximately 85 Vac (for the 115 Vac range), or less than approximately 145 Vac (for the 230 Vac range), during operation.

The power source delivers no current.

The power source returns to operation, when the voltage becomes greater than respectively 90 and 150 Vac approximately, remaining at reduced performance levels until the voltage approaches the rated value.

3.4.5 - Yellow led (B) flashes (three fast flash with 1,5 seconds pause).

Alarm for inside driver circuits supply voltage excessive. This is generally a phenomenon which may damage the power source if you continue working.

To restore operation, shut off the power source, wait for the capacitors inside to discharge completely (9 minutes), and restart the power source at the rated voltage.

If the alarm returns, replace the power board (13).

4 - COMPONENTS LIST**4.1 - Power source art. 254: see file ESP254.pdf enclosed at the end of the manual.****4.2 - Components table: see file ESP254.pdf enclosed at the end of the manual.****4.3 - Spare parts list.****Essential spare parts.**

Ref.	Code	Description	Qty.
13	5602044	power board	1

Recommended spare parts.

Ref.	Code	Description	Qty.
5	3190014	switch	1
9	3165075	fan	1
10	5602045	filter board	1

5 - ELECTRICAL DIAGRAMS

5.1 - Power source art. 254: see file SCHE254.pdf enclosed at the end of the manual.

5.2 - Filter board (10) cod. 5.602.045/A.

5.2.1 - Topographical drawing.

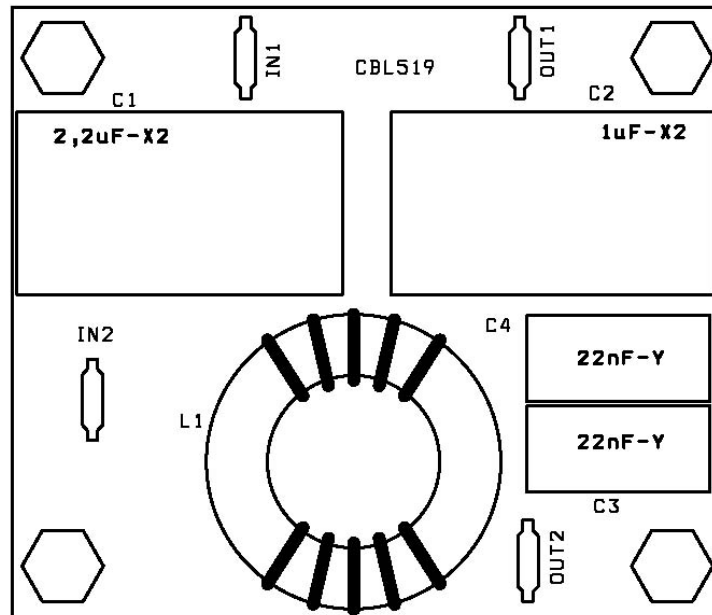

5.2.2 - Connector table.

Terminals	Function
IN1 - IN2	power source voltage supply input.
OUT1 - OUT2	power supply output to power board (13).

5.3 - Power board (13) code 5.602.044/G.

5.3.1 - Connector table.

Terminals	Function
P1 - P2	power board (13) voltage supply input.
(+) - (-)	power board (13) output.

5.3.2 - Topographical drawing.

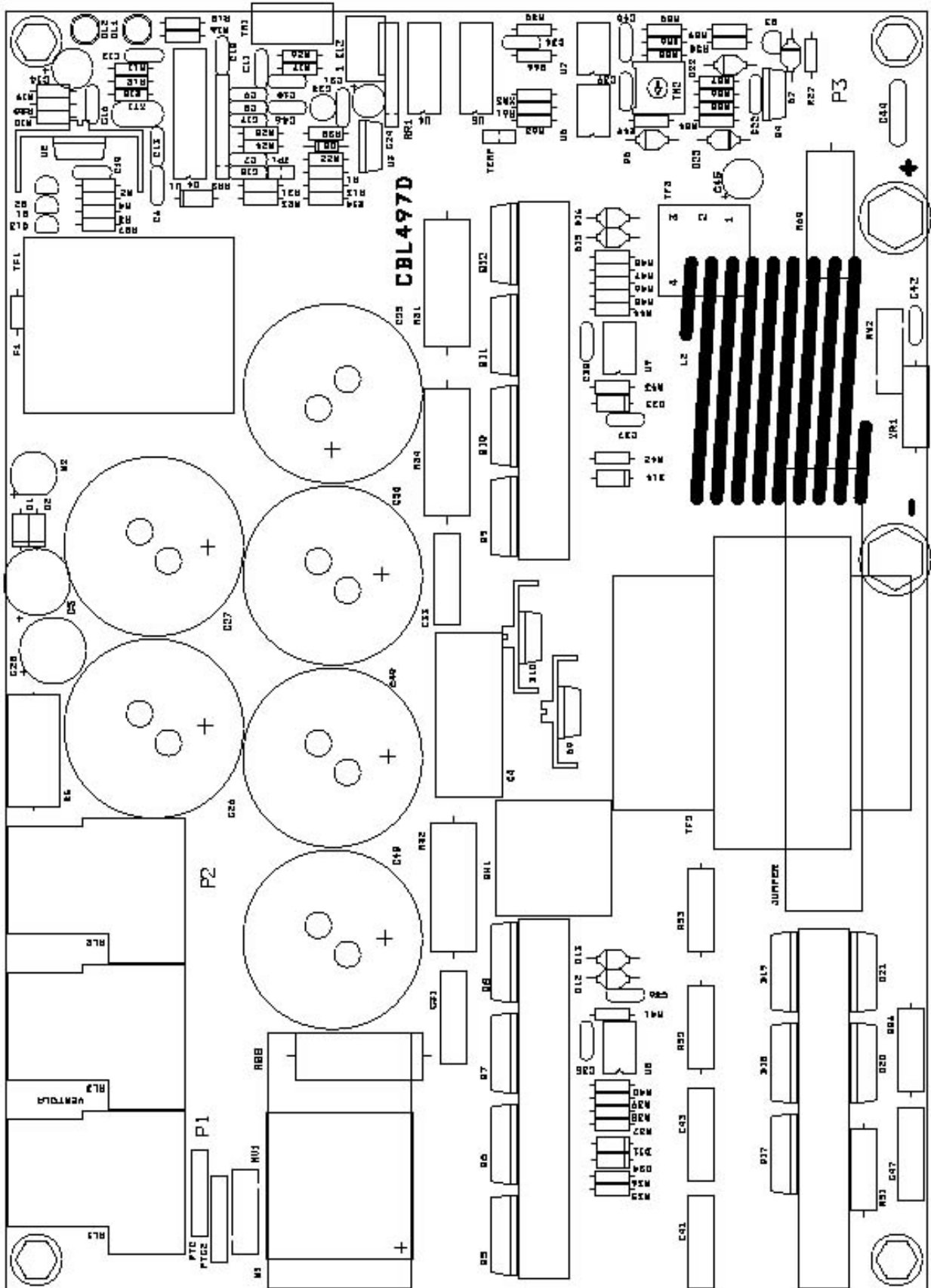

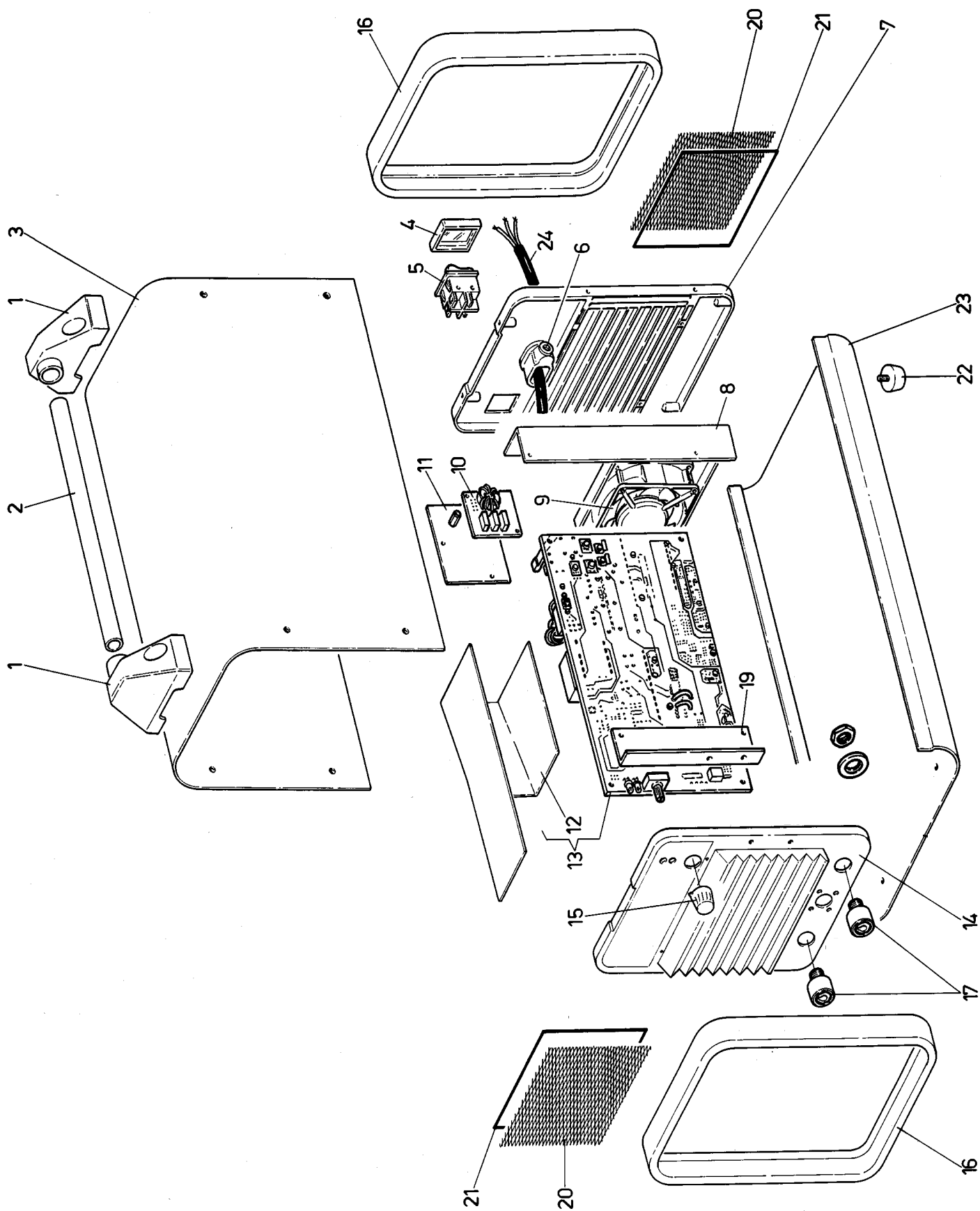

pos	DESCRIZIONE	DESCRIPTION
01	SUPPORTO MANICO	HANDLE SUPPORT
02	MANICO	HANDLE
03	FASCIONE	HOUSING
04	COPERTURA IN GOMMA	RUBBER MAT
05	INTERRUTTORE	SWITCH
06	PRESSACAVO	STRAIN RELIEF
07	PANNELLO POSTERIORE	BACK PANEL
08	SUPPORTO VENTOLA	FAN SUPPORT
09	MOTORE CON VENTOLA	MOTOR WITH FAN
10	CIRCUITO FILTRO	FILTER CIRCUIT
11	SUPPORTO	SUPPORT
12	COPERTURA	COVER
13	CIRCUITO DI POTENZA	POWER CIRCUIT

pos	DESCRIZIONE	DESCRIPTION
14	PANNELLO ANTERIORE	FRONT PANEL
15	MANOPOLA	KNOB
16	CORNICE	FRAME
17	PRESA	SOCKET
18		
19	SUPPORTO	SUPPORT
20	RETE METALLICA	WIRE NETTING
21	CORNICE	FRAME
22	PIEDE IN GOMMA	RUBBER FOOT
23	FONDO	BOTTOM
24	CAVO RETE	POWER CORD
25		

La richiesta di pezzi di ricambio deve indicare sempre: numero di articolo, matricola e data di acquisto della macchina, posizione e quantità del ricambio.

When ordering spare parts please always state the machine item and serial number and its purchase data, the spare part position and the quantity.

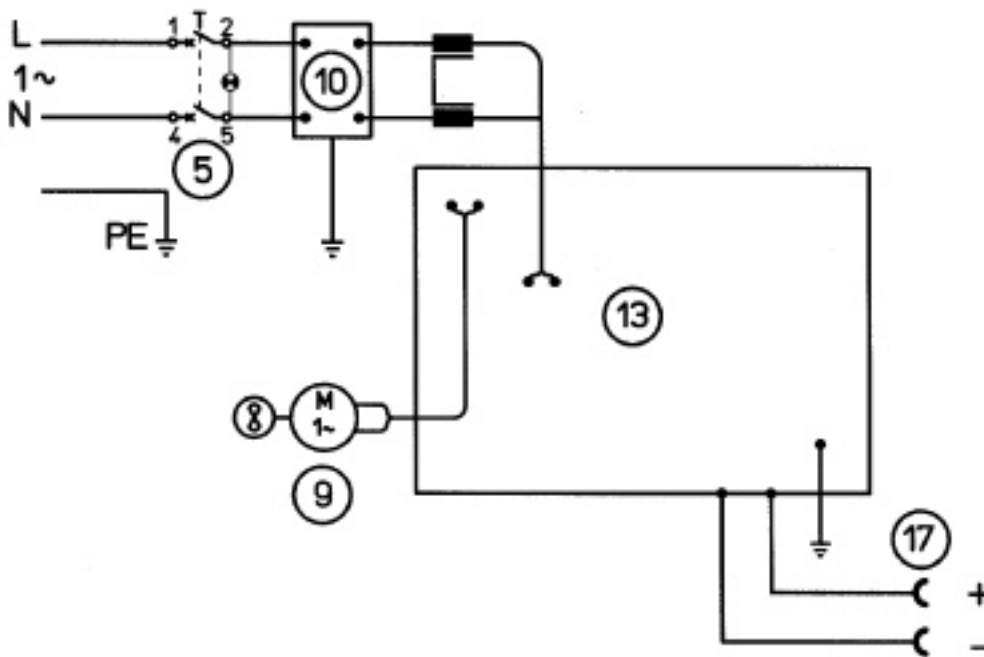

CODIFICA COLORI CABLAGGIO ELETTRICO		WIRING DIAGRAM COLOUR CODE
A	NERO	BLACK
B	ROSSO	RED
C	GRIGIO	GREY
D	BIANCO	WHITE
E	VERDE	GREEN
F	VIOLA	PURPLE
G	GIALLO	YELLOW
H	BLU	BLUE
K	MARRONE	BROWN
J	ARANCIO	ORANGE
I	ROSA	PINK

CODIFICA COLORI CABLAGGIO ELETTRICO		WIRING DIAGRAM COLOUR CODE
L	ROSA-NERO	PINK-BLACK
M	GRIGIO-VIOLA	GREY-PURPLE
N	BIANCO-VIOLA	WHITE-PURPLE
O	BIANCO-NERO	WHITE-BLACK
P	GRIGIO-BLU	GREY-BLUE
Q	BIANCO-ROSSO	WHITE-RED
R	GRIGIO-ROSSO	GREY-RED
S	BIANCO-BLU	WHITE-BLUE
T	NERO-BLU	BLACK-BLUE
U	GIALLO-VERDE	YELLOW-GREEN
V	AZZURRO	BLUE